

# USER MANUAL

PLEASE READ THE INSTRUCTIONS CAREFULLY BEFORE RIDING



VSETT8

VSETT8+

VSETT9

VSETT9+

VSETT10+

VSETT11+

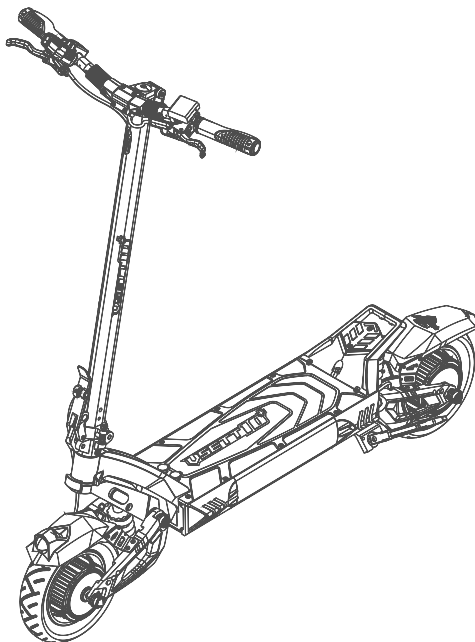

TEMPERATURE CONTROL



NFC



OFF - ROAD



DUAL MOTOR



HYDRAULIC BRAKE

# CONTENT

GENERAL INFORMATION .....	1
VSETT RANGE - CONTROL LAYOUT, FUNCTIONS AND SPECIFICATIONS .....	2~13
INTELLIGENT TEMPERATURE CONTROL MANAGEMENT SYSTEM .....	14~15
VSETT DISPLAY OPERATION AND PROGRAMMING .....	16~25
FOLDING HANDLE BARS .....	26~27
SUSPENSION ADJUSTMENT .....	28
BATTERY AND CHARGING .....	29~30
PRE RIDE CHECKS .....	31
WARNING .....	32
LIMITED WARRANTY .....	33~34
ERROR CODES .....	35~36
INCLUDED IN THE BOX .....	37

# READ THIS MANUAL BEFORE USING

## IMPORTANT INFORMATION

### WHY IS IT NECESSARY TO READ THIS MANUAL BEFORE OPERATING?

This manual was written to help you understand the proper use and maintenance of the VSETT line of Electric Scooter.

It is important to review the features and functions of your new VSETT electric scooter before using it for your own safety and enjoyment.

Your VSETT scooter will require a 100km running-in period and may need some adjustments to components.

The VSETT unit will require some adjustments and break-in period for all moving parts to adjust themselves into the correct position.

**BEFORE RIDING:** Please ensure that the folding mechanism is firmly locked in place and that the safety lock is engaged.



## DISCLAIMER & WARNING

The product and its brand VSETT (company name) is not liable for any accidental damages related to the usage of this product.

### **WARNING!**

It is your sole responsibility to ensure your VSETT scooter is regularly maintained to ensure it is safe to use.

- ALWAYS WEAR A HELMET WHEN RIDING
- ALWAYS FOLLOW LOCAL LAWS AND REGULATIONS
- NEVER RIDE SCOOTER IN POOR VISIBILITY
- DO NOT DO STUNTS, WHEELIES or JUMPS IF YOU DO NOT HAVE THE PROPER SAFETY EQUIPMENT.

# VSETT8

TURN SIGNAL SWITCH

FOLDABLE HANDLE BAR

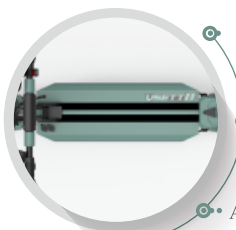

BATTERY 48V 15.6AH  
48V 19.2AH LG  
48V 21.0AH LG

MAX RANGE  
80KM ECO / 100KM ECO / 110KM ECO

ADJUSTABLE FRONT AND REAR SUSPENSION

ELECTRONIC BRAKING + DRUM BRAKES



MAX SPEED  
38-42KM/H

NFC KEY LOCK



TELESCOPING BAR

FOLDING UNIT

CONTROLLER  
48V 23AH

LED LIGHTS

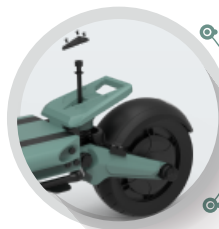

REAR WHEEL: SOLID 8\*2 INCH

CLIMBING ABILITY: 25 DEG

MOTOR REAR 600W

REAR DRUM BRAKES

TURN SIGNAL+BRAKE LIGHT



FRONT WHEEL:  
PNEUMATIC TYRE 8.5\*3 INCH

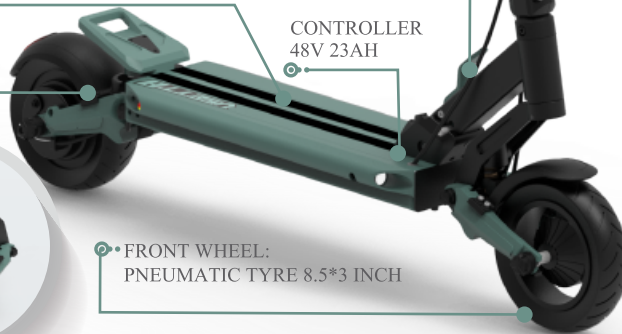

Model	VSETT 8
Battery	48V 15.6AH / 48V 19.2AH / 48V 21.0AH
Tire	Front:8.5*3 inch pneumatic tire, Rear:8*2 inch solid tire
Brakes	Front and rear drum brakes+Electric brake
Max Range	80km/100km/110km
Top Speed (Limited to)	38-42km/h
Weight	21KG
Suspension	Front and rear adjustable shock absorption
Lights	Front spotlight + Rear brake light + Front and rear turn signal
Controller	48V 23A
Motor Power	48V 600W
Max Load	120kg



Maximum load and speed may vary depending on the rider's weight, riding style and terrain.

# VSETT8+

TURN SIGNAL SWITCH  
FOLDABLE HANDLE BAR  
DDM SWITCH

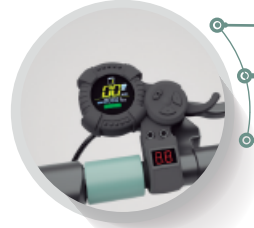

MAX SPEED  
40-45KM/H  
NFC KEY LOCK

TELESCOPING BAR  
LED LIGHTS

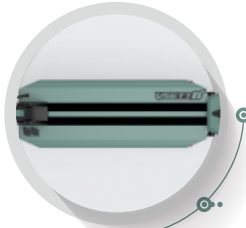

BATTERY 48V 16.0AH LG  
MAX RANGE  
DUAL MOTORS: 50KM  
SINGLE MOTOR: 90KM

ELECTRONIC BRAKING + DRUM BRAKES + (FRONT+REAR)



FOLDING UNIT

CONTROLLER  
48V 23AH X 2

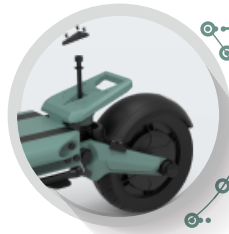

REAR WHEEL: SOLID 8\*2 INCH  
CLIMBING ABILITY: 25 DEG  
MOTOR 600W  
REAR DRUM BRAKES  
TURN SIGNAL+BRAKE LIGHT  
SPRING SUSPENSION



FRONT WHEEL: SOLID 8\*2 INCH  
MOTOR 48V 600W

Model	VSETT 8+
Battery	48V 16.0AH
Tire	8 *2 Inch solid tire
Brakes	Front and rear drum brakes+Electric Brake
Max Range	Dual drive: 50KM / Single drive: 90KM
Top Speed (Limited to)	40-45KM/H
Weight	25KG
Suspension	Front and rear adjustable shock absorption
Lights	Front spotlight + Rear brake light and turn signal
Controller	48V 23A X 2
Motor Power	48V 600W X 2
Max Load	120KG



Maximum load and speed may vary depending on the rider's weight, riding style and terrain.

# VSETT9

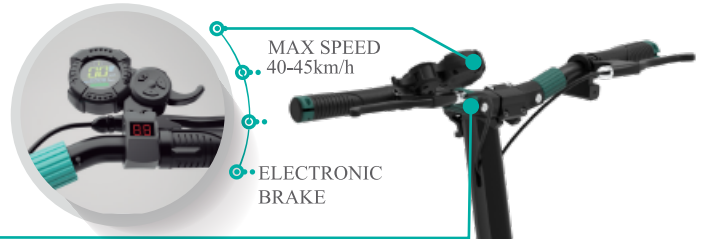

- FOLDABLE HANDLE BAR
- MECHANICAL BRAKE LEVERS
- NFC KEY LOCK
- ELECTRONIC HORN
- TURN SIGNAL SWITCH



- ELECTRONIC BRAKE +  
MECH DISC BRAKE SYSTEM
- MAX RANGE  
55KM ECO / 70KM ECO / 80KM ECO
- BATTERY  
52V 13.0AH / 52V 16.0AH / 52V 17.5AH



THE HOOK:  
FIX HOOK AND  
PREVENT SLIDING



FOLDING UNIT



- CLIMBING  
ABILITY 25 DEG
- 650W MOTOR
- TURN SIGNAL, BRAKE LIGHT
- SUSPENSION  
FRONT/REAR ADJUSTABLE  
SPRING SHOCKS
- 8.5 INCH PNEUMATIC TIRE  
8.5\*3 IN
- REAR DISC BRAKE

- 8.5 INCH PNEUMATIC TIRE  
8.5 x 3 IN
- FRONT DISC BRAKE
- LED HEAD LIGHT



- CONTROLLER  
52V 23A
- ADJUSTABLE  
SPRING SUSPENSION



Model	VSETT 9
Battery	52V 13A/52V 16A/52V 17.5A
Tire	8.5*3 Inch pneumatic tire
Brakes	Front and rear disc brakes + Electric Brake
Max Range	55km/70km/80km
Top Speed (Limited to)	40-45KM/H
Weight	23KG
Suspension	Front and rear adjustable shock absorption
Lights	Front spotlight+Rear brake light+Front and rear turn signal
Controller	52V 23A
Motor Power	52V 650W
Max Load	120KG

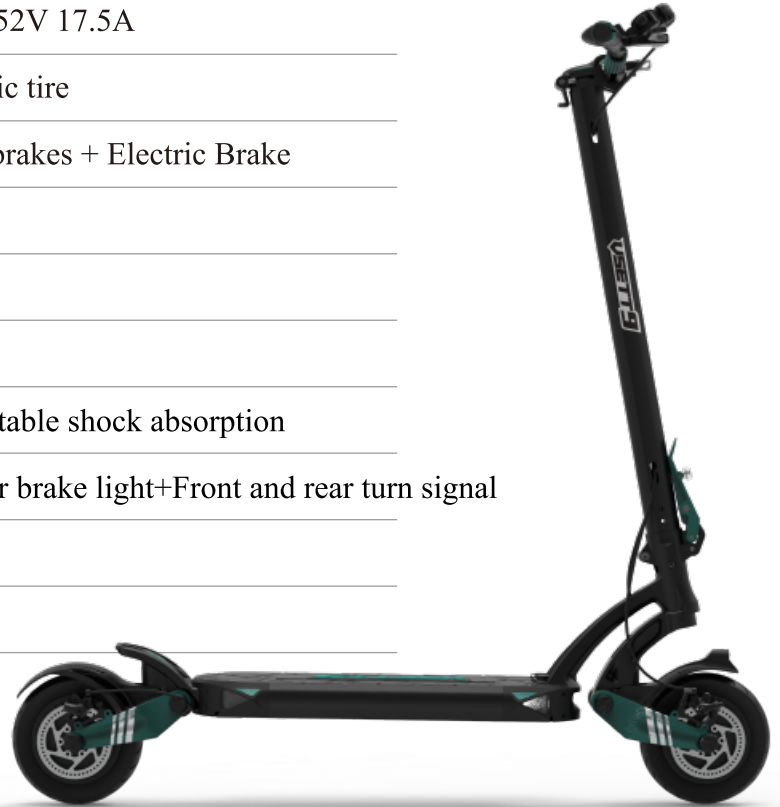

Maximum load and speed may vary depending on the rider's weight, riding style and terrain.

# VSETT9+

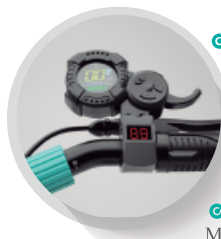

- MAX SPEED 48-53KM
- CONTROLLER 48V 23A X 2

• ELECTRONIC BRAKE + MECH DISC BRAKE SYSTEM



- DDM SWITCH
- NFC KEY LOCK
- ERGONOMIC FOLDABLE HANDLEBAR
- ELECTRONIC HORN
- MECHANICAL BRAKE LEVERS
- TURN SIGNAL SWITCH



• RUGGED FOLDING LEVER

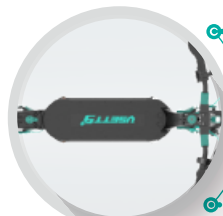

- MAXIMUM RANGE:
- SINGLE MOTOR 70KM/90KM/100KM
- DUAL MOTOR 40KM/50KM/55KM
- MOTOR POWER 650W X 2
- BATTERY 48V 15.6AH / 48V 19.2AH / 48V 21AH

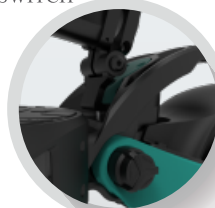

• THE HOOK: FIX HOOK AND PREVENT SLIDING



- CLIMBING ABILITY 25 DEG
- 650W REAR MOTOR
- TURN SIGNAL, BRAKE LIGHT

• SUSPENSION FRONT/REAR ADJUSTABLE SPRING SHOCKS

- 1.8 INCH PNEUMATIC TIRE 8.5 X 3 IN
- REAR DISC BRAKE

- 650W FRONT MOTOR
- 1.8 INCH PNEUMATIC TIRE 8.5 X 3 IN
- FRONT DISC BRAKE
- LED HEAD LIGHT



• CONTROLLER 48V 23A X 2

• ADJUSTABLE SPRING SUSPENSION

Model	VSETT 9+
Battery	48V 15.6AH / 48V 19.2AH / 48V 21.0AH
Tire	8.5*3 Inch pneumatic tire
Brakes	Front and rear disc brakes + Electric Brake
Max Range	70KM/90KM/100KM (single drive) 40KM/50KM/55KM (dual drive)
Top Speed (Limited to)	48-53KM/H
Weight	25KG
Suspension	Front and rear adjustable shock absorption
Lights	Front spotlight + Rear brake light+Front and rear turn signal
Controller	48V 23A X 2
Motor Power	48V 650W X 2
Max Load	120KG



Maximum load and speed may vary depending on the rider's weight, riding style and terrain.

# VSETT10+



- MAX SPEED 80KM/H (SPORT)
- ELECTRONIC BRAKE + HYDRAULIC BRAKE SYSTEM
- CONTROLLER 60V, (30A-35A)\*2
- FOLD THE HANDLE

DDM SWITCH



RUGGED FOLDING LEVER



- HYDRAULIC BRAKE LEVERS
- TURBO BOOST
- NFC KEY LOCK
- ERGONOMIC FOLDABLE HANDLEBAR
- ELECTRONIC HORN
- TURN SIGNAL SWITCH

CONTROLLER 60V, (30A-35A)\*2

MAXIMUM RANGE  
 DRIVE 130KM/160KM/185KM  
 DUAL DRIVE 65KM/80KM/90KM

MOTOR POWER  
 1400W X 2

BATTERY  
 60V 20.8AH / 60V 25.6AH / 60V 28AH

TURN SIGNAL, BRAKE LIGHT

1400W REAR MOTOR

SUSPENSION  
 FRONT: SPRING SUSPENSION  
 REAR: HYDRAULIC SUSPENSION

PNEUMATIC TYRE 10\*3INCH

HYDRAULIC DISC BRAKES  
 ELECTRIC BRAKE

FRONT WHEEL: PNEUMATIC TYRE 10\*3INCH

HYDRAULIC FRONT DISC BRAKE

1400W FRONT MOTOR

ADJUSTABLE SPRING SUSPENSION

ULTRA BRIGHT LED HEADLIGHT



Model	VSETT 10+
Battery	60V 20.8AH / 60V 25.6AH / 60V 28.0AH
Tire	10*3 inch pneumatic tire
Brakes	Front and rear hydraulic brakes + electric brake
Max Range	Single motor 130KM/160KM/185KM Dual motors 65KM/80KM/90KM
Top Speed (Limited to)	Dual Mode: 65-70KMH/40-44MMH Sport Mode:75-80KMH/46-50MMH
Weight	36KG
Suspension	Front spring suspension+Rear hydraulic suspension
Lights	Front spotlight + Rear brake light + Front and rear turn signal + LED light
Controller	60V (30-35 A)*2
Motor Power	60V 1400W X 2
Max Load	130KG



Maximum load and speed may vary depending on the rider's weight, riding style and terrain.

# VSETT11+



- MAX SPEED 85KM/H(SPORT)
- ELECTRONIC BRAKE + HYDRAULIC BRAKE SYSTEM



- TURN SIGNAL SWITCH
- HYDRAULIC BRAKE LEVERS
- TURBO BOOST
- NFC KEY LOCK
- SINGLE AND DOUBLE DRIVE SWITCH
- ELECTRONIC HORN



- CONTROLLER 60 V (40-45A) \*2
- MAX RANGE SINGLE DRIVE 160KM/220KM DUAL DRIVE 80KM/110KM
- MOTOR POWER 1500W X 2
- BATTERY 60V 31.2A/60V 42A(LG)
- TURN SIGNAL



- LED HEADLIGHT



- FOLDING SWITCH



- 1500W REAR MOTOR
- SUSPENSION FRONT: HYDRAULIC SHOCK ABSORPTION REAR: HYDRAULIC DOUBLE SHOCK ABSORPTION



- PNEUMATIC TYRE 11\*4INCH
- HYDRAULIC DISC BRAKES
- FRONT WHEEL: PNEUMATIC TYRE 11\*4INCH
- HYDRAULIC DISC BRAKE
- 1500W FRONT MOTOR
- HYDRAULIC SUSPENSION

Model	VSETT 11+ MODEL
Battery	60V 31.2A/60V 42A
Tire	11*4 Inch
Brakes	Electric Brake+Automatic power off function+Front and rear hydraulic brakes
Max Range(Single Motor)	160KM/220KM
Max Range(Dual Motors)	80KM/110KM
Max Speed	Dual Mode: 70-75KPH/44-47MPH / Sport Mode:80-85KPH/50-53MPH
Weight	58KG
Suspension	Front -Rear Hydraulic Suspensions / Patented Hydraulic suspension
Lights	LED lights + Double LED headlights and taillights + Brake lights + Turn signal
Motor Power	60V 1500W* 2 BRUSHLESS MOTORS
Controller	60V (40-45A)*2
Max Load	150KG



Maximum load and speed may vary depending on the rider's weight, riding style and terrain.

## INTELLIGENT TEMPERATURE CONTROL MANAGEMENT SYSTEM

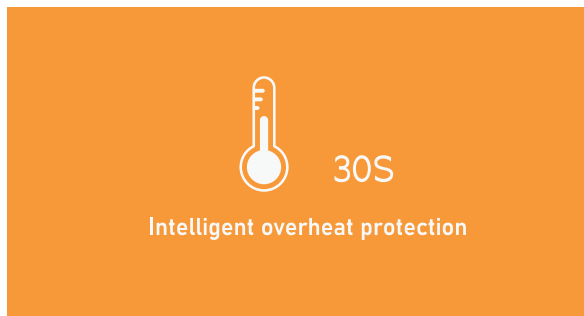

The motor controller/s fitted to your VSETT electric scooter feature overload protection. Should the controller temperature exceed the safety threshold, the management system will enter a 30s protection cycle. Should you experience a loss of power due to overload, please stop riding and allow the controller time to cool.



Should you resume riding and a second overload event is triggered, the management system will enter a longer protection cycle. You will be unable to operate the scooter for between 2-3 min. The system will reset once the controller temperature drops down to normal levels





## VSETT series electric scooter intelligent temperature control system

(A 75KG load was tested according to the summer climate in Ningbo, China)

Serial number	Model	First protection temperature (According to the local topography $\pm 5^{\circ}\text{C}$ )	First protection time (According to local climatic conditions $\pm 5\text{s}$ )	Limit protection temperature (According to the local topography $\pm 5^{\circ}\text{C}$ )	Limit protection duration (According to local climatic conditions $\pm 5\text{s}$ )
1	VSETT8	85 $^{\circ}\text{C}$	30s	90 $^{\circ}\text{C}$	2-3m
2	VSETT8+	85 $^{\circ}\text{C}$	30s	90 $^{\circ}\text{C}$	2-3m
3	VSETT9	80 $^{\circ}\text{C}$	30s	90 $^{\circ}\text{C}$	2-3m
4	VSETT9+	80 $^{\circ}\text{C}$	30s	90 $^{\circ}\text{C}$	2-3m
5	VSETT10+	70 $^{\circ}\text{C}$	30s	75 $^{\circ}\text{C}$	2-3m
6	VSETT11+	100 $^{\circ}\text{C}$	30s	105 $^{\circ}\text{C}$	2-3m



## Basic operation:

### 1- Function

#### 1. Displayed content:

Speedometer / Odometer / Trip meter / Battery level / Cruise-control active light / Gear indicator / Fault warning light

#### 2. All content on display(power on within 1 second)

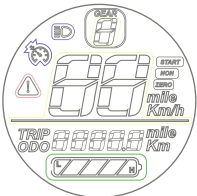

### 3.1 Speed display area



Unit: MPH, KM/H

The speed signal is taken from the Hall signal inside the motor. Sent to controller by controller (Time of single Hall period, unit: IMS). The display calculate the true speed based on wheel diameter and signal data calculate the true speed (The motor Holzer also needs to set the number of magnetic steel)

### 3.2 Vehicle power gear adjustment,



0-3 digital display;

### 3.3 vehicle status display area



Zero start and non-zero start prompt;

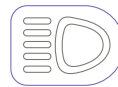

Lights on indicator;



Cruise control active indicator;



Fault prompt;

## Vset display operation and programming

Display P-Codes (Programming codes)

To access this menu, long-press  and . Use  button to scroll through P-codes,  and  to change parameters.

P01: Backlight brightness:The 1 level is the darkest, Level 3 brightest; Default: 3

P02: Mileage: unit,0: KM; 1: MILE; Default: KM

P03: Voltage level: 24V, 36V, 48V, 52V, 60V.

P04: Dormancy time:0 means no dormancy;Other numbers are dormant time.The range is 1-60 minute.Default:5

P05: Reserve

P06: Wheel diameter: The unit is inch. The accuracy is 0.1; Default:10.0

P07: Speed measuring magnetic steel number.The range is 0-255. Default:28

P08: Rate-limiting: The range is 0-100km/h.Default: 100

P09: Zero start\ no zero start setting; 0 means zero start.1means no Zero start.Default: 0

P10:Reserve

P11: EABS switch choose.The range is 1-5.0 means closing.1 means weakest.2 means strongest.

P12: Soft and hard start strength.The range is 1-5. The softest is 1.The hardest is5.Default: 3

P13: Reserve

P14: Reserve

P15: Controller under-voltage

P16: ODO Zero setting: keep pressing + for 5 seconds,ODO will zero clearing.

P17: When it shows 0,it can not use cruise.When it shows 1,it can use cruise.Default:0



P18: Bind and unbind NFC CARDS.Long press "+" to build the binding, long press "-" to build the unbinding

P19: Reserve

P20: Communication protocol is defaults 4.It can not change.







## 2、 Introduction of buttons and interfaces



1. When it is shutdown, Long-press - hold button continuously for 2s  to turn on the power. When it is power on ,It can change interface between the ODO、 TRIP、 VOL, by pressing  for short time.

2. When it is power on, Long-press - hold button continuously for 2s  to turn off, Press   to change gear.

3. Long-press  and  to enter P-code menu - refer to functions on page 18.

Enter the menu setting interface, press  or  to increase or decrease the value (long press  to change the direction of the addition or subtraction of the value, and "A" on the left indicates the increase value, and "D" on the left indicates the decrease value), after the modification is finished;Press  to switch to the next parameter and save the value of the previous parameter;After parameter modification, long press  +  again to exit the setting interface, or wait for 8 seconds for automatic exit and save parameters.

## 3、 Card binding instructions

1.The instrument is not bound to ID card:

After starting up, the LCD displays the normal contents, and the card swiping area displays the power voltage. At this time, the meter can directly enter the working state.

The diagram below:



2.How to bind ID card:

CARDS are bound by factory default

Late setting: When using mobile phone or NFC functional card binding, refer to the following methods

Long press  for 5 seconds to display B 0. At this time, the ID card is close to the card swiping area and B 1 is displayed, indicating that the card is tied successfully and the default is unlimited.

Press  for 5 seconds to display C 0. At this time, all ID CARDS that have been unbound are displayed.

3. The instrument has been bound with ID card: after starting up, the LCD displays card, the power voltage is not displayed in the card swiping area, and the swiping indicator flashes, indicating that the card needs to be swiped to start up. At this time, the accelerator does not work.

The diagram below:



**Note:** Due to the upgrade of the company's products, some of the displayed contents of the products you get may be different from the instructions, but it will not affect your normal use.

If the NFC cards are lost accidentally, you can try to contact the local agents. (each E-Scooter is equipped with 3 keys).

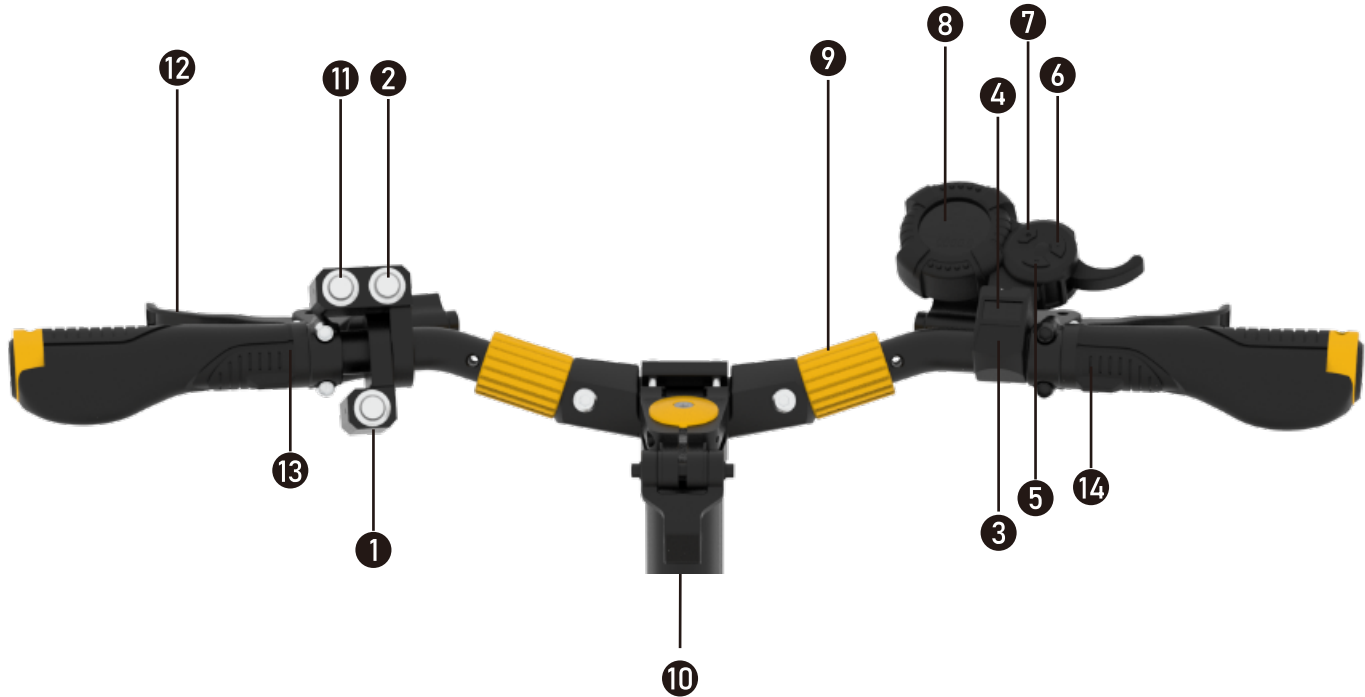

1. Horn
2. Single motor dual motor switching
3. NFC
4. Voltage Meter
5. Long-press Lights on
6. Positive Button / Turn on the light
7. Mode / Enter Button

8. Display
9. Handle Folding Mechanism
10. Stem Folding Mechanism
11. Turbo / NOz Button
12. Brake
13. Left turn signal
14. Right turn signal



## Text

Power On/Off	Press the power button for [7] seconds to turn on/off the scooter. then use NFC card to active it The scooter turns off automatically if not used for 90 seconds
Speed Control	While stationary, and with the power on, press the [5] & [6] button to cycle through the three different speed levels 1 to 3. Use the throttle to control the speed within each speed level.
Headlight	While power is on, press and hold Front Light button to turn on or off headlight.
Mileage & Other data	While stationary, and with the power on, press and release the [7] button to cycle through the following data: ODO (lifetime mileage), TRIP mileage, VOLTAGE level, ELECTRICAL CURRENT level and ERROR CODE.
Turbo / NOz Button	While at maximum speed, press the Turbo / NOz [11] button to get a short boost while riding



## TURNING IT ON

Press the  for 3 seconds and wait to be prompted for the Token (Card).

Tap the Token (Card)  to the IR reader NFC 

---

## PSETTING

Press and hold both  and  simultaneously for 3 seconds to access the P Setting interface.

---

## CHANGING OF SPEED

Press the  once or the  to toggle between increasing between 1 to 3.

Function is to limit max limit, 3 being themax speed able to achieve.

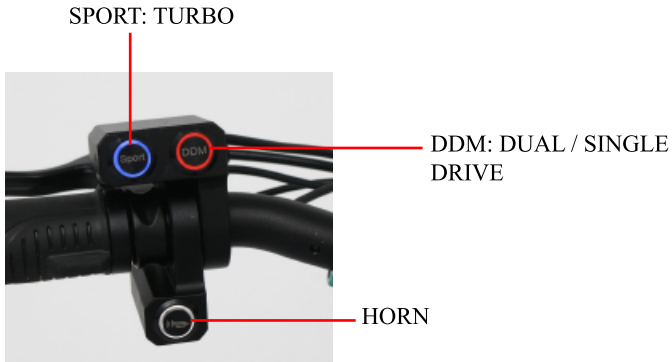

Press the  once to activate the Dual Drive Motor function. Pressing it again will allow Single Drive Motor Function

Press the  more power, faster, last for two minutes, can't close in the middle, can restart after five minutes

Press the  once to activate the horn. Button are able to be hold on or to press once.



Press the button and the light flashes. Automatic shutdown after 12 seconds. Turn signals can only be on one side at a time. One side opens and the other side automatically closes

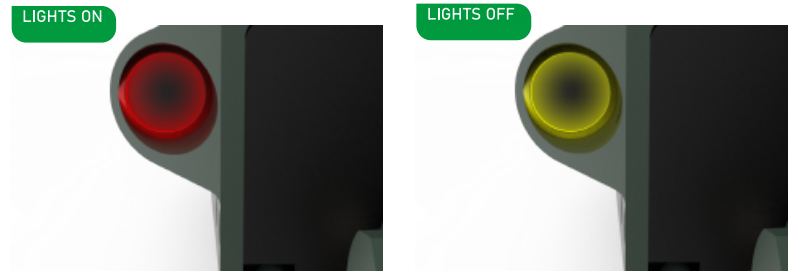

## Folding handle bars

1

Turn the handle screw anti - clockwise to loose the mechanism



2

Once loosen, pull the screw catch away from each other



3

Simultaneously fold the handle bar down



4

Finish



1 Loosen the safety screw



2 Plate opening and folding buckle



3 Pull up safety pin



4 Once the main lever is released, ensure that the capture is also released



5 Insert buckle

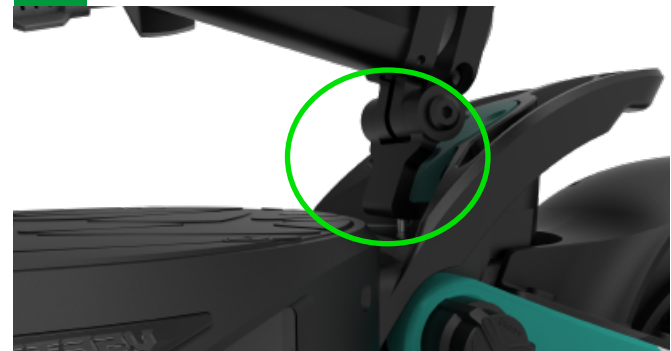

## SUSPENSION ADJUSTMENT

1. Firstly, Please loosen the bottom screw (as shown in Figure A)
2. Secondly, Please open the colored block on the back (front) pedal (as shown in Figure B below)
3. Thirdly, Please Use the combination tool to rotate the screw on the back (front) pedal (Figure B) to the appropriate position
4. Lastly, Please Tighten the loose screw at the bottom again (Figure A)



A(back)

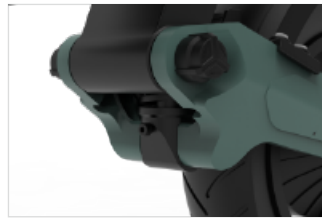

A(front)



B (back)



B (front)

## BATTERY

- Do not operate the scooter while charging
- Do not store the scooter over a long period of time with an almost empty battery.
- From time to time, discharge the battery by riding. Have the battery recharge again and make sure to not leave battery fully empty.

### DO NOT DO ANY CHARGING IF THE BOARD:

- is broken
- emits an unusual odour or colorless liquid.
- the bottom of the deck or it as a whole gets into excessive heating
- leakage is present.

Avoid contacting with substance or meddling with a bloated battery. Keep the battery away from children, pets or direct heat. Exposure to the battery voltage may cause death or serious injury.

The use, storage or charging of the VSETT battery outside specified limits may result in the annulment of the warranty, battery damage and an effective battery charging,



It is important to fully charge the battery before your first use of the scooter.

### First Charge

---

**Your scooter's battery comes with these built-in features:**

1. Balanced charging protection: During charging, the battery automatically balances the voltage among the internal cells to protect each cell.
2. Over-charging protection: The battery stops charging automatically when full to protect against damage.
3. Over current protection: The battery automatically stops charging if the voltage is higher than prescribed voltage to protect the battery.
4. Over discharging protection: The battery automatically stops discharging when its voltage drops below Under voltage value to protect the battery.
5. Short-circuit protection: the battery automatically stops output in the case of a short-circuit.

---

### How to charge

1. Ensure that scooter is TURNED OFF. Connect external power charger to scooter.
2. Connect charger to electrical outlet, then turn on the power of electrical outlet.
3. Do not charge the batteries in temperatures below 5 °C or above 40 °C. The battery may stop the charging process.
4. Charging Light **RED** - Battery is charging.  
Charging Light **Green** - Battery is fully charged.



# PRE RIDE CHECKS

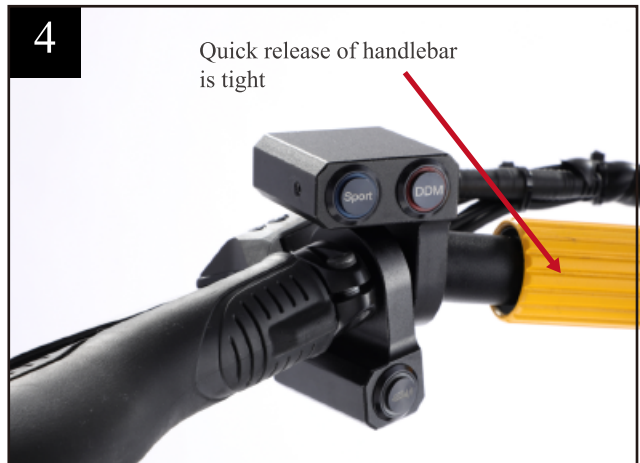



## WARNING!

Certain countries of regions require safety devices or gear. It is your responsibility to know the state laws and follow them. However, we strongly recommend safety gears to be donned before operating the device.

TIRE AIR PRESSURE: THE TIRE IS PRESSURIZED TO THE STANDARD VALUE ON THE TIRE

### SAFETY GEAR

Helmet: Most common and serious injuries from riding are head injuries. This can be prevented by wearing a helmet... You must wear a helmet when riding the VSETT. The helmet must be worn according to their instruction

### MECHANICAL SAFETY

Before using the VSETT:

- 1) Always perform a visual inspection of all screws and nuts are tight and in place. If anything is amiss or missing and you are unsure, please bring it back to the authorized distributor.
- 2) Check the tyres and wheels and that it is not showing signs of wear and tear; not in need of replacement. Always ensure that the brake mechanism is not touching the wheels and allows free spinning.
- 3) Always perform mechanical checks of brakes and other parts of the scooter that allows visibility, safety and functionality of the scooter to be



BY USING THIS PRODUCT YOU AGREE TO THIS LIMITED WARRANTY. PLEASE READ THIS LIMITED WARRANTY CAREFULLY.

To benefit from the limited warranty, the customer is advised to read Vsett Warranty terms together with the “care and maintenance” sections provided in the user manual. This limited warranty applies to the extent permitted by law and unless restricted or prohibited by law.

## Limited Warranty Details

1. Vsett warrants that Vsett scooter products (“Products” or “Product”), are free from defects in material and workmanship, according to the following terms and conditions:
2. This Limited Warranty extends to the original purchaser of the Product warranted under this warranty and to each transferee of the Product during the first \_\_\_\_\_ months beginning on (date) \_\_\_\_\_ as stated below (“Warranty Period”).

This Limited Warranty covers the Product and each of its following component parts (“Components”) only:

- a. Hub motor;
  - b. Battery packs (except if battery was short circuited or seals of the battery enclosure or cells were broken or were tempered or the battery was used in equipment other than its intended use);
  - c. Controller;
  - d. Throttle and battery indicator unit;
  - e. Charger unit;
  - f. All other electrical wiring and components.
3. During the Warranty Period, Vsett or its authorized service centres will repair or replace, at Vsett’s option and without costs to the customer, any defective Components with new or factory rebuilt replacement items, and return the Products to the customer in working condition, provided that the terms and conditions of this Limited Warranty are met. All defective Products or Components that have been replaced shall become the properties of Vsett.
  4. Products and/or Components that have been repaired or replaced pursuant to the paragraph above will be covered by this Limited Warranty for the balance of the Warranty Period.
  5. This Limited Warranty will only be effective when presented together, to either Vsett or its authorised centres, with proof of date and place of purchase of Products such as the purchase receipt.

What this Limited Warranty does not cover:

1. Products used for commercial purpose(s) including but not limited to leasing/hiring, use in competitions etc
2. Any logistical costs of returning the Product to Vsett or its authorised service centres for servicing or the cost of returning the Product to the customer after servicing.
3. Defects or damages resulting from use of the Product(s) other than its normal and customary manner as stated in the user manuals accompanying the Products.
4. Defects or damages from improper storage, exposure to moisture or dampness, modifications, connections, repairs (except as carried out by Vsett or its authorised centres), misuse, neglect, abuse, accident, alteration, improper installation, or other acts which are not the fault of Vsett, including damage caused by dropping, blown fuses, spills of food or liquid.
5. Defects or malfunctions of the product not notified by customer during the Warranty Period.
6. Products which have had their serial numbers removed or tampered with.
7. This Limited Warranty is in lieu of all other warranties, express or implied either in fact or by operations of law, statutory or otherwise, including, but not limited to any implied warranty of marketability or fitness for a particular use.

5. Defects or malfunctions of the product not notified by customer during the Warranty Period.
6. Products which have had their serial numbers removed or tampered with.
7. This Limited Warranty is in lieu of all other warranties, express or implied either in fact or by operations of law, statutory or otherwise, including, but not limited to any implied warranty of marketability or fitness for a particular use.

**Disclaimer:**

1. The customer understands the risk of serious injury or death in the operation of such products and shall agree to take the **necessary precautions** and exercise **good judgement** to avoid hazards and dangerous situations which may result in serious injury or death.
2. The customer shall agree to indemnify and hold harmless Vsett from all injuries or death arising from the operation of the product.
3. The use of safety and protective gear such as bicycle helmets is strongly encouraged. And so is the use of Good Judgement.
4. The customer is advised to take the following precautions:
  - a. Take corners slowly and look out for pedestrians;
  - b. Avoid potholes, kerbs and debris on the ground;
  - c. Keep tires pumped to the specified pressure;
  - d. Dismount in places with heavy human traffic and push the scooter manually;
  - e. Service the product every 3 months on regular usage, 6 months for non-frequent usage;
  - f. Do not use product on public roads and respect local road regulations.

**How to request service under this Limited Warranty:**

To obtain performance of Vsett to repair and/or replace the Product or its Components under this Limited Warranty, the customer must, during the Warranty Period:

1. Bring this Limited Warranty, proof of purchase and the Product to Vsett.
2. Provide Vsett with a written description of the problem.

The average repair time is 1 to 3 days, not including shipping time to and from our service centre.

This warranty does not cover the shipping costs associated with the transportation of the scooter to and from our service centre, and a fee will be charged for return shipping or pick up and delivery service.

**What can the consumer do in case of a dispute with Vsett**

The consumer and Vsett agree that in the event of a dispute arising from the material and workmanship of the Product; or from this Limited Warranty, parties will attempt to first resolve the matter by negotiating in good faith.

## ERROR CODE

<b>Error Code</b>	<b>Fault</b>	<b>Diagnostic Step</b>	<b>Resolution</b>
00	Normal Status	Normally ok; Turn off and on the scooter to see if the error persists	Normally ok
02	Brake	Check brake lever on handlebar and see if brake springs back all the way	Give the brake lever a few hard presses to ensure that it is not stuck; If jammed, then unclog the source of the jam
		Check brake caliper to see if the brake line is springing back to original position	If brake caliper is not springing back, spray some WD40 to make sure it springs back to original position
06	Battery Undervoltage	Check LCD setting P03 and P15; Give battery a full charge to see if issue persists	P03 should be in accordance to the voltage specified in the user manual. P15 should be the specified voltage - 6V
07	Motor Fault	Unplug and plug motor connector back in to see if issue persists	If problem is resolved, then make sure connector is pushed in all the way.
		If issue persists; check motor wire and connector pins to see if there are any issues	Either replace the motor or replace motor wire.



Brake Sensor Activated



## ERROR CODES

Error Code	Fault	Diagnostic Step	Resolution
08	Turnstile Fault	Check if back screw or magnet has come loose in the throttle/LCD	Tighten back screw or replace magnet in the throttle
09	Controller Fault	Replace controller	Replace controller
10	Communication Receiving Fault	Unplug and plug in LCD connector and see if issue persists; IF issue persists, then wiggle the LCD wire in different directions to see if problem persists	Change of wiring harness from LCD to controller might be needed if the issue persists
11	Communication Transmission Fault	Unplug and plug in controller connector and see if issue persists; IF issue persists, then wiggle the LCD wire in different directions to see if problem persists	Change of wiring harness from LCD to controller might be needed if the issue persists



**Brake Sensor Activated**

## Included in the box

SERIAL NUMBER	ITEM	QUANTITY
1	Charger	1
2	Combination tool	1
3	Instruction book	1
4	NFC card	3
5	Reflective sticker	2

**NEW MODELS ARE COMING SOON**

-  Web:[www.vsett.com](http://www.vsett.com)
-  Facebook:VSETT
-  Instagram:vsett.escooters
-  YouTube:VSETT
-  E-mail:[sales@vsett.com](mailto:sales@vsett.com)

**USER MANUAL**

NINGBO VSETT INTELLIGENT TECHNOLOGY CO.,LTD

